

Fig. 1

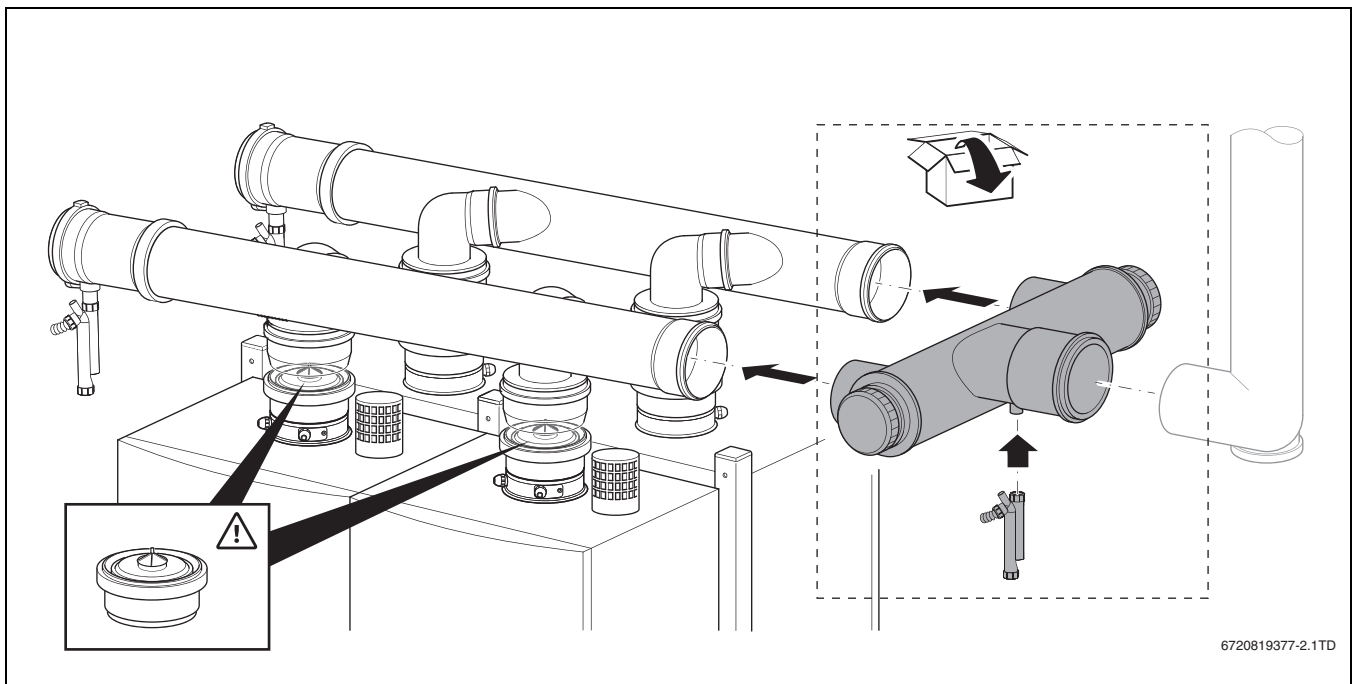

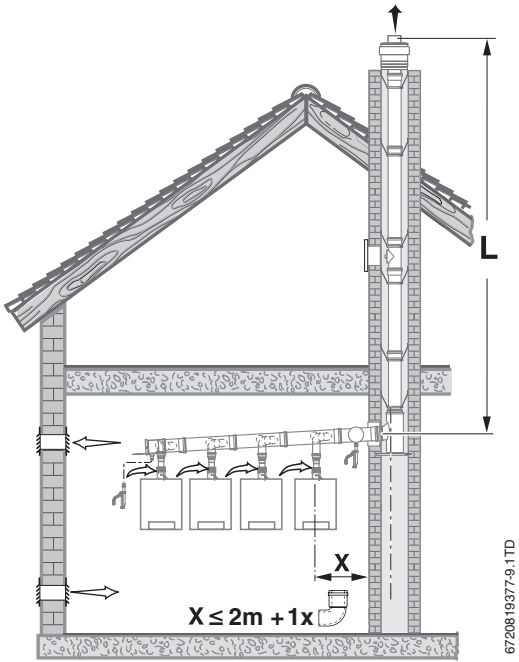
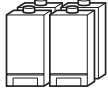
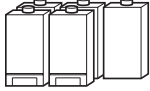
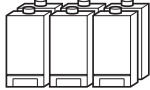
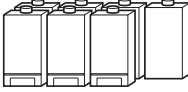
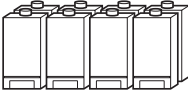

Fig. 2

Flue gas Y-piece (overpressure)

		X 	ØB [mm]	Type 	L [m]
B <sub>23P</sub>		<b>4</b> 	DN 200	50	50
				70 <sup>1)</sup>	50
				85	50
				100	50
		<b>5</b> 	DN 200	50	50
				70 <sup>1)</sup>	50
		<b>6</b> 	DN 200	70 <sup>1)</sup>	21
				85	18
			DN 250	70 <sup>1)</sup>	50
				85	50
		<b>7</b> 	DN 200	70 <sup>1)</sup>	3
				85	50
DN 250	70 <sup>1)</sup>		50		
	85		50		
<b>8</b> 	DN 250	70 <sup>1)</sup>	50		
		85	50		
				100	28

Tab. 1

Country	70 <sup>1)</sup>
UK/IE	Logamax plus GB162-65
TR	Buderus Logamax plus GB162-69 Bosch Condens 5000 W ZBR 69-3
CN	Bosch LN1GBQ63-(ZBR-3)

