

MX200

Logamatic SET MX200 for TC100

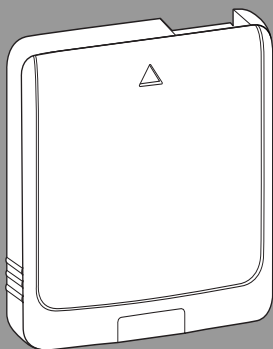

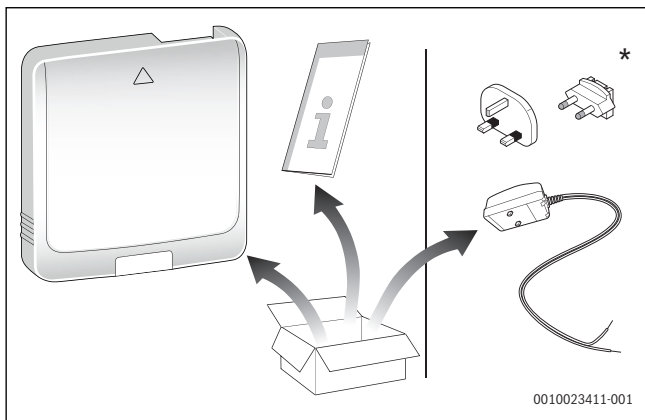

1

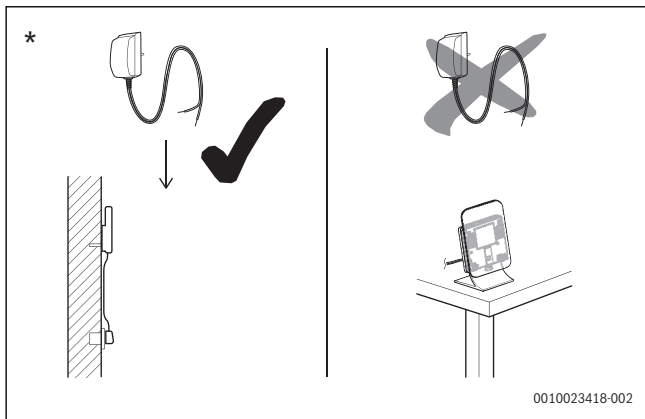

2

2



MyMode app

ANDROID APP ON



Google™ play



Available on the
App Store

0010025803-001

3

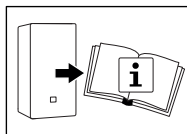
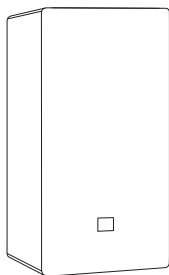

0010023472-001

4

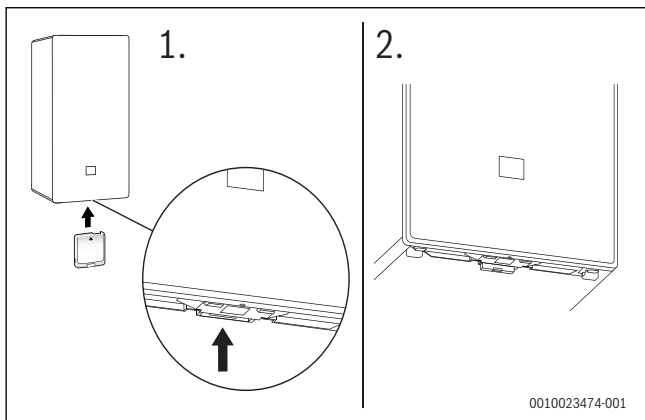



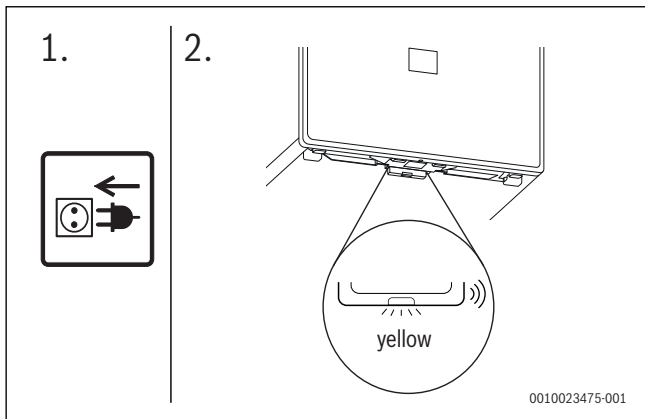









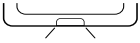

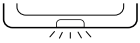

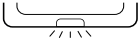
5



6

4

LED red				
LED yellow				
LED yellow				
LED green	 			
LED off				OFF
RESET				

1

	Units	MX200
U	V_{DC}	12-23
P_{max}	W	1 W (1000 mW)
f (RF)	MHz	868.3 ... 869.5 [EU] (P= max. 10dBm)
IP-class		IP30
T_{amb}	°C	0-50
m	g (lb)	38.6 (0.850)
	mm (inch)	h = 65 (2.55) w = 65 (2.55) d = 15 (0.59)
BUS		EMS plus

2

-
- de** Der nachfolgende Text ist aus rechtlichen Gründen in Englisch.
- en** The following text is in English for legal reasons.
- fr** Le texte suivant est en anglais pour des raisons juridiques.
- es** Por motivos legales, el siguiente texto está en inglés.
- cs** Následující text je z právních důvodů v angličtině.
- da** Følgende tekst er på engelsk af juridiske årsager.
- et** Järgnev tekst on õiguslikel põhjustel inglise keeles.
- fi** Seuraava teksti on oikeudellisista syistä englanniksi.
- hr** Sljedeći je tekst iz pravnih razloga napisan na engleskom jeziku.
- hu** A következő szöveg jogi okokból angolul szerepel.
- it** Il testo seguente è in inglese per motivi giuridici.
- lt** Žemiau esantis tekstas dėl teisinių priežasčių pateiktas anglų kalba.
- lv** Turpmākais teksts tiesisku iemeslu dēļ ir angļu valodā.
- nl** De navolgende tekst is om juridische redenen in het Engels.
- no** Den følgende tekst er på engelsk av juridiske årsaker.
- pl** Poniższy tekst z przyczyn prawnych sporządzony jest w języku angielskim.
- pt** O texto seguinte encontra-se em inglês por imperativos jurídicos.
- ro** Din motive juridice, următorul text este în limba engleză.
- ru** Следующий текст представлен на английском языке из правовых соображений.
- sk** Nasledovný text je z právnych dôvodov uvedený v angličtine.
- sl** Spodnje besedilo je iz pravnih razlogov v angleškem jeziku.
- sr** Tekst koji sledi je iz pravnih razloga na engleskom jeziku.
- sv** Följande text är av juridiska skäl på engelska .
- tr** Aşağıdaki metin, yasal nedenlerden dolayı İngilizcedir.
- fi** De navolgende tekst is om juridische redenen in het Engels.
- el** Το παρακάτω κείμενο είναι για νομικούς λόγους στα Αγγλικά.
- bg** Следващият текст е на английски език поради правни съображения.
- uk** Наведений нижче текст з юридичних причин написано англійською мовою.

1 Used Commercial Source Components

1.1 This product contains software developed and licensed by SEGGER Software GmbH

2 List of used Open Source Components.

This document contains a list of open source software (OSS) components used within the product under the terms of the respective licenses. The source code corresponding to the open source components is also provided along with the product wherever mandated by the respective OSS license

The following open source software (OSS) components are included in this product:

Name of OSS Component	Version of OSS Component	Name and Version of License (License text can be found in Appendix below)	More Information
MBED_ARM	Unspecified	Apache License 2.0 → chapter 3.1	Copyright © 2006-2015, ARM Limited Copyright © 2016, ARM Limited Copyright © 2006-2018, Arm Limited Copyright © 2006-2017, ARM Limited Copyright © 2006-2016, ARM Limited Copyright © 2014-2017, ARM Limited Copyright © 2014-2016, ARM Limited Copyright © 2009-2016, ARM Limited Copyright © 2013-2016, ARM Limited
ST Generated	Unspecified	BSD (Three Clause License) → chapter 3.2	Copyright © 2009 - 2015 ARM LIMITED

Name of OSS Component	Version of OSS Component	Name and Version of License (License text can be found in Appendix below)	More Information
STM32cube generated files	Unspecified	BSD (Three Clause License) → chapter 3.2	COPYRIGHT© 2016 STMicroelectronics COPYRIGHT© 2014 STMicroelectronics
STMC4Lib-IAR	Unspecified	BSD (Three Clause License) → chapter 3.2	Copyright © 2009 - 2015 ARM LIMITED COPYRIGHT© 2016 STMicroelectronics
stm32f30x	Unspecified	MCD-ST Liberty Software License Agreement v2 → chapter 3.5	COPYRIGHT © 2012 STMicroelectronics
TI-RTOS	2.21.00.06	BSD (Three Clause License) → chapter 3.2 EPL-1.0 License → chapter 3.3	Copyright © 2012, Texas Instruments Incorporated Copyright © 2013 Texas Instruments and others
XDCTools	3.32.00.06	Eclipse Distribution License - v 1.0 → chapter 3.4 EPL-1.0 License → chapter 3.3	Copyright © 2008 Texas Instruments Copyright © 2008 Texas Instruments

Provided that within certain OSS-Licenses (e.g. LGPL-2.0) necessary, reverse-engineering is allowed for the respective software component to the required extent. This shall not apply for other components of the software.

3 Appendix - License text incl. Copyright information

3.1 Apache License 2.0

Apache License Version 2.0, January 2004

<http://www.apache.org/licenses/>

TERMS AND CONDITIONS FOR USE, REPRODUCTION, AND DISTRIBUTION

1. Definitions.

"License" shall mean the terms and conditions for use, reproduction, and distribution as defined by Sections 1 through 9 of this document.

"Licensor" shall mean the copyright owner or entity authorized by the copyright owner that is granting the License.

"Legal Entity" shall mean the union of the acting entity and all other entities that control, are controlled by, or are under common control with that entity. For the purposes of this definition, "control" means (i) the power, direct or indirect, to cause the direction or management of such entity, whether by contract or otherwise, or (ii) ownership of fifty percent (50%) or more of the outstanding shares, or (iii) beneficial ownership of such entity.

"You" (or "Your") shall mean an individual or Legal Entity exercising permissions granted by this License.

"Source" form shall mean the preferred form for making modifications, including but not limited to software source code, documentation source, and configuration files.

"Object" form shall mean any form resulting from mechanical transformation or translation of a Source form, including but not limited to compiled object code, generated documentation, and conversions to other media types.

"Work" shall mean the work of authorship, whether in Source or Object form, made available under the License, as indicated by a copyright notice that is included in or attached to the work (an example is provided in the Appendix below).

"Derivative Works" shall mean any work, whether in Source or Object form, that is based on (or derived from) the Work and for which the editorial revisions, annotations, elaborations, or other modifications represent, as a whole, an original work of authorship. For the purposes of this License, Derivative Works shall not include works that remain separable from, or merely link (or bind by name) to the interfaces of, the Work and Derivative Works thereof.

"Contribution" shall mean any work of authorship, including the original version of the Work and any modifications or additions to that Work or Derivative Works thereof, that is intentionally submitted to Licensor for inclusion in the Work by the copyright owner or by an individual or Legal Entity authorized to submit on behalf of the copyright owner. For the purposes of this definition, "submitted" means any form of electronic, verbal, or written communication sent to the Licensor or its representatives, including but not limited to communication on electronic mailing lists, source code control systems, and issue tracking systems that are managed by, or on behalf of, the Licensor for the purpose of discussing and improving the Work, but excluding communication that is conspicuously marked or otherwise designated in writing by the copyright owner as "Not a Contribution".

"Contributor" shall mean Licensor and any individual or Legal Entity on behalf of whom a Contribution has been received by Licensor and subsequently incorporated within the Work.

2. Grant of Copyright License.

Subject to the terms and conditions of this License, each Contributor hereby grants to You a perpetual, worldwide, non-exclusive, no-charge, royalty-free, irrevocable copyright license to

reproduce, prepare Derivative Works of, publicly display, publicly perform, sublicense, and distribute the Work and such Derivative Works in Source or Object form.

3. Grant of Patent License.

Subject to the terms and conditions of this License, each Contributor hereby grants to You a perpetual, worldwide, non-exclusive, no-charge, royalty-free, irrevocable (except as stated in this section) patent license to make, have made, use, offer to sell, sell, import, and otherwise transfer the Work, where such license applies only to those patent claims licensable by such Contributor that are necessarily infringed by their Contribution(s) alone or by combination of their Contribution(s) with the Work to which such Contribution(s) was submitted. If You institute patent litigation against any entity (including a cross-claim or counterclaim in a lawsuit) alleging that the Work or a Contribution incorporated within the Work constitutes direct or contributory patent infringement, then any patent licenses granted to You under this License for that Work shall terminate as of the date such litigation is filed.

4. Redistribution.

You may reproduce and distribute copies of the Work or Derivative Works thereof in any medium, with or without modifications, and in Source or Object form, provided that You meet the following conditions:

You must give any other recipients of the Work or Derivative Works a copy of this License; and
You must cause any modified files to carry prominent notices stating that You changed the files; and

You must retain, in the Source form of any Derivative Works that You distribute, all copyright, patent, trademark, and attribution notices from the Source form of the Work, excluding those notices that do not pertain to any part of the Derivative Works; and

If the Work includes a "NOTICE" text file as part of its distribution, then any Derivative Works that You distribute must include a readable copy of the attribution notices contained within such NOTICE file, excluding those notices that do not pertain to any part of the Derivative Works, in at least one of the following places: within a NOTICE text file distributed as part of the Derivative Works; within the Source form or documentation, if provided along with the Derivative Works; or, within a display generated by the Derivative Works, if and wherever such third-party notices normally appear. The contents of the NOTICE file are for informational purposes only and do not modify the License. You may add Your own attribution notices within Derivative Works that You distribute, alongside or as an addendum to the NOTICE text from the Work, provided that such additional attribution notices cannot be construed as modifying the License.

You may add Your own copyright statement to Your modifications and may provide additional or different license terms and conditions for use, reproduction, or distribution of Your modifications, or for any such Derivative Works as a whole, provided Your use, reproduction, and distribution of the Work otherwise complies with the conditions stated in this License.

5. Submission of Contributions.

Unless You explicitly state otherwise, any Contribution intentionally submitted for inclusion in the Work by You to the Licensor shall be under the terms and conditions of this License, without any additional terms or conditions. Notwithstanding the above, nothing herein shall supersede or modify the terms of any separate license agreement you may have executed with Licensor regarding such Contributions.

6. Trademarks.

This License does not grant permission to use the trade names, trademarks, service marks, or product names of the Licensor, except as required for reasonable and customary use in describing the origin of the Work and reproducing the content of the NOTICE file.

7. Disclaimer of Warranty.

Unless required by applicable law or agreed to in writing, Licensor provides the Work (and each Contributor provides its Contributions) on an "AS IS" BASIS, WITHOUT WARRANTIES OR CONDITIONS OF ANY KIND, either express or implied, including, without limitation, any warranties or conditions of TITLE, NON-INFRINGEMENT, MERCHANTABILITY, or FITNESS FOR A PARTICULAR PURPOSE. You are solely responsible for determining the appropriateness of using or redistributing the Work and assume any risks associated with Your exercise of permissions under this License.

8. Limitation of Liability.

In no event and under no legal theory, whether in tort (including negligence), contract, or otherwise, unless required by applicable law (such as deliberate and grossly negligent acts) or agreed to in writing, shall any Contributor be liable to You for damages, including any direct, indirect, special, incidental, or consequential damages of any character arising as a result of this License or out of the use or inability to use the Work (including but not limited to damages for loss of goodwill, work stoppage, computer failure or malfunction, or any and all other commercial damages or losses), even if such Contributor has been advised of the possibility of such damages.

9. Accepting Warranty or Additional Liability.

While redistributing the Work or Derivative Works thereof, You may choose to offer, and charge a fee for, acceptance of support, warranty, indemnity, or other liability obligations and/or rights consistent with this License. However, in accepting such obligations, You may act only on Your own behalf and on Your sole responsibility, not on behalf of any other Contributor, and only if You agree to indemnify, defend, and hold each Contributor harmless for any liability incurred by, or claims asserted against, such Contributor by reason of your accepting any such warranty or additional liability.

3.2 BSD (Three Clause License)

Copyright (c) <YEAR>, <OWNER>

All rights reserved.

Redistribution and use in source and binary forms, with or without modification, are permitted provided that the following conditions are met:

Redistributions of source code must retain the above copyright notice, this list of conditions and the following disclaimer.

Redistributions in binary form must reproduce the above copyright notice, this list of conditions and the following disclaimer in the documentation and/or other materials provided with the distribution.

Neither the name of the <ORGANIZATION> nor the names of its contributors may be used to endorse or promote products derived from this software without specific prior written permission.

THIS SOFTWARE IS PROVIDED BY THE COPYRIGHT HOLDERS AND CONTRIBUTORS "AS IS" AND ANY EXPRESS OR IMPLIED WARRANTIES, INCLUDING, BUT NOT LIMITED TO, THE IMPLIED WARRANTIES OF MERCHANTABILITY AND FITNESS FOR A PARTICULAR PURPOSE ARE DISCLAIMED. IN NO EVENT SHALL THE COPYRIGHT OWNER OR CONTRIBUTORS BE LIABLE FOR ANY DIRECT, INDIRECT, INCIDENTAL, SPECIAL, EXEMPLARY, OR CONSEQUENTIAL DAMAGES (INCLUDING, BUT NOT LIMITED TO, PROCUREMENT OF SUBSTITUTE GOODS OR SERVICES; LOSS OF USE, DATA, OR PROFITS; OR BUSINESS INTERRUPTION) HOWEVER CAUSED AND ON ANY THEORY OF LIABILITY, WHETHER IN CONTRACT, STRICT LIABILITY, OR TORT (INCLUDING NEGLIGENCE OR OTHERWISE) ARISING IN ANY WAY OUT OF THE USE OF THIS SOFTWARE, EVEN IF ADVISED OF THE POSSIBILITY OF SUCH DAMAGE.

3.3 EPL-1.0 License

THE ACCOMPANYING PROGRAM IS PROVIDED UNDER THE TERMS OF THIS ECLIPSE PUBLIC LICENSE ("AGREEMENT"). ANY USE, REPRODUCTION OR DISTRIBUTION OF THE PROGRAM CONSTITUTES RECIPIENT'S ACCEPTANCE OF THIS AGREEMENT.

1. DEFINITIONS

"Contribution" means:

a) in the case of the initial Contributor, the initial code and documentation distributed under this Agreement, and

b) in the case of each subsequent Contributor:

i) changes to the Program, and

ii) additions to the Program;

where such changes and/or additions to the Program originate from and are distributed by that particular Contributor. A Contribution 'originates' from a Contributor if it was added to the Program by such Contributor itself or anyone acting on such Contributor's behalf. Contributions do not include additions to the Program which: (i) are separate modules of software distributed in conjunction with the Program under their own license agreement, and (ii) are not derivative works of the Program.

"Contributor" means any person or entity that distributes the Program.

"Licensed Patents" mean patent claims licensable by a Contributor which are necessarily infringed by the use or sale of its Contribution alone or when combined with the Program.

"Program" means the Contributions distributed in accordance with this Agreement.

"Recipient" means anyone who receives the Program under this Agreement, including all Contributors.

2. GRANT OF RIGHTS

a) Subject to the terms of this Agreement, each Contributor hereby grants Recipient a non-exclusive, worldwide, royalty-free copyright license to reproduce, prepare derivative works of, publicly display, publicly perform, distribute and sublicense the Contribution of such Contributor, if any, and such derivative works, in source code and object code form.

b) Subject to the terms of this Agreement, each Contributor hereby grants Recipient a non-exclusive, worldwide, royalty-free patent license under Licensed Patents to make, use, sell, offer to sell, import and otherwise transfer the Contribution of such

Contributor, if any, insource code and object code form. This patent license shall apply to the combination of the Contribution and the Program if, at the time the Contribution is added by the Contributor, such addition of the Contribution causes such combination to be covered by the Licensed Patents. The patent license shall not apply to any other combinations which include the Contribution. No hardware per se is licensed hereunder.

c) Recipient understands that although each Contributor grants the licenses to its Contributions set forth herein, no assurances are provided by any Contributor that the Program does not infringe the patent or other intellectual property rights of any other entity. Each Contributor disclaims any liability to Recipient for claims brought by any other entity based on infringement of intellectual property rights or otherwise. As a condition to exercising the rights and licenses granted hereunder, each Recipient hereby assumes sole responsibility to secure any other intellectual property rights needed, if any. For example, if a third party patent license is required to allow Recipient to distribute the Program, it is Recipient's responsibility to acquire that license before distributing the Program.

d) Each Contributor represents that to its knowledge it has sufficient copyright rights in its Contribution, if any, to grant the copyright license set forth in this Agreement.

3. REQUIREMENTS

A Contributor may choose to distribute the Program in object code form under its own license agreement, provided that:

a) it complies with the terms and conditions of this Agreement; and

b) its license agreement:

i) effectively disclaims on behalf of all Contributors all warranties and conditions, express and implied, including warranties or conditions of title and non-infringement, and implied warranties or conditions of merchantability and fitness for a particular purpose;

ii) effectively excludes on behalf of all Contributors all liability for damages, including direct, indirect, special, incidental and consequential damages, such as lost profits;

iii) states that any provisions which differ from this Agreement are offered by that Contributor alone and not by any other party; and

iv) states that source code for the Program is available from such Contributor, and informs licensees how to obtain it in a reasonable manner on or through a medium customarily used for software exchange.

When the Program is made available in source code form:

- a) it must be made available under this Agreement; and
- b) a copy of this Agreement must be included with each copy of the Program.

Contributors may not remove or alter any copyright notices contained within the Program.

Each Contributor must identify itself as the originator of its Contribution, if any, in a manner that reasonably allows subsequent Recipients to identify the originator of the Contribution.

4. COMMERCIAL DISTRIBUTION

Commercial distributors of software may accept certain responsibilities with respect to end users, business partners and the like. While this license is intended to facilitate the commercial use of the Program, the Contributor who includes the Program in a commercial product offering should do so in a manner which does not create potential liability for other Contributors. Therefore, if a Contributor includes the Program in a commercial product offering, such Contributor ("Commercial Contributor") hereby agrees to defend and indemnify every other Contributor ("Indemnified Contributor") against any losses, damages and costs (collectively "Losses") arising from claims, lawsuits and other legal actions brought by a third party against the Indemnified Contributor to the extent caused by the acts or omissions of such Commercial Contributor in connection with its distribution of the Program in a commercial product offering. The obligations in this section do not apply to any claims or Losses relating to any actual or alleged intellectual property infringement. In order to qualify, an Indemnified Contributor must: a) promptly notify the Commercial Contributor in writing of such claim, and b) allow the Commercial Contributor to control, and cooperate with the Commercial Contributor in, the defense and any related settlement negotiations. The Indemnified Contributor may participate in any such claim at its own expense. For example, a Contributor might include the Program in a commercial product offering, Product X. That Contributor is then a Commercial Contributor. If that Commercial Contributor then makes performance claims, or offers warranties related to Product X, those performance claims and warranties are such Commercial Contributor's responsibility alone. Under this section, the Commercial Contributor would have to defend claims against the other Contributors related to those performance claims and warranties, and if a court requires any other Contributor to pay any damages as a result, the Commercial Contributor must pay those damages.

5. NO WARRANTY

EXCEPT AS EXPRESSLY SET FORTH IN THIS AGREEMENT, THE PROGRAM IS PROVIDED ON AN "AS IS" BASIS, WITHOUT WARRANTIES OR CONDITIONS OF ANY KIND, EITHER EXPRESS OR IMPLIED INCLUDING, WITHOUT LIMITATION, ANY WARRANTIES OR CONDITIONS OF TITLE, NON-INFRINGEMENT, MERCHANTABILITY OR FITNESS FOR A PARTICULAR PURPOSE. Each Recipient is solely responsible for determining the appropriateness of using and distributing the Program and assumes all risks associated

with its exercise of rights under this Agreement, including but not limited to the risks and costs of program errors, compliance with applicable laws, damage to or loss of data, programs or equipment, and unavailability or interruption of operations.

6. **DISCLAIMER OF LIABILITY**

EXCEPT AS EXPRESSLY SET FORTH IN THIS AGREEMENT, NEITHER RECIPIENT NOR ANY CONTRIBUTORS SHALL HAVE ANY LIABILITY FOR ANY DIRECT, INDIRECT, INCIDENTAL, SPECIAL, EXEMPLARY, OR CONSEQUENTIAL DAMAGES (INCLUDING WITHOUT LIMITATION LOST PROFITS), HOWEVER CAUSED AND ON ANY THEORY OF LIABILITY, WHETHER IN CONTRACT, STRICT LIABILITY, OR TORT (INCLUDING NEGLIGENCE OR OTHERWISE) ARISING IN ANY WAY OUT OF THE USE OR DISTRIBUTION OF THE PROGRAM OR THE EXERCISE OF ANY RIGHTS GRANTED HEREUNDER, EVEN IF ADVISED OF THE POSSIBILITY OF SUCH DAMAGES.

7. **GENERAL**

If any provision of this Agreement is invalid or unenforceable under applicable law, it shall not affect the validity or enforceability of the remainder of the terms of this Agreement, and without further action by the parties hereto, such provision shall be reformed to the minimum extent necessary to make such provision valid and enforceable.

If Recipient institutes patent litigation against any entity (including a cross-claim or counterclaim in a lawsuit) alleging that the Program itself (excluding combinations of the Program with other software or hardware) infringes such Recipient's patent(s), then such Recipient's rights granted under Section 2(b) shall terminate as of the date such litigation is filed.

All Recipient's rights under this Agreement shall terminate if it fails to comply with any of the material terms or conditions of this Agreement and does not cure such failure in a reasonable period of time after becoming aware of such noncompliance. If all Recipient's rights under this Agreement terminate, Recipient agrees to cease use and distribution of the Program as soon as reasonably practicable. However, Recipient's obligations under this Agreement and any licenses granted by Recipient relating to the Program shall continue and survive.

Everyone is permitted to copy and distribute copies of this Agreement, but in order to avoid inconsistency the Agreement is copyrighted and may only be modified in the following manner. The Agreement Steward reserves the right to publish new versions (including revisions) of this Agreement from time to time. No one other than the Agreement Steward has the right to modify this Agreement. The Eclipse Foundation is the initial Agreement Steward. The Eclipse Foundation may assign the responsibility to serve as the Agreement Steward to a suitable separate entity. Each new version of the Agreement will be given a distinguishing version number. The Program (including Contributions) may always be distributed subject to the version of the Agreement under which it was received. In addition, after a new version of the Agreement is published, Contributor may elect to distribute the Program (including its Contributions) under the new version. Except as expressly stated in Sections 2(a) and 2(b) above, Recipient receives no rights or licenses to the intellectual property of any Contributor under this Agreement, whether expressly, by implication, estoppel or otherwise. All rights in the

Program not expressly granted under this Agreement are reserved.

This Agreement is governed by the laws of the State of New York and the intellectual property laws of the United States of America. No party to this Agreement will bring a legal action under this Agreement more than one year after the cause of action arose. Each party waives its rights to a jury trial in any resulting litigation.

3.4 Eclipse Distribution License - v 1.0

Copyright (c) 2007, Eclipse Foundation, Inc. and its licensors.

All rights reserved.

Redistribution and use in source and binary forms, with or without modification, are permitted provided that the following conditions are met:

- Redistributions of source code must retain the above copyright notice, this list of conditions and the following disclaimer.
- Redistributions in binary form must reproduce the above copyright notice, this list of conditions and the following disclaimer in the documentation and/or other materials provided with the distribution.
- Neither the name of the Eclipse Foundation, Inc. nor the names of its contributors may be used to endorse or promote products derived from this software without specific prior written permission.

THIS SOFTWARE IS PROVIDED BY THE COPYRIGHT HOLDERS AND CONTRIBUTORS "AS IS" AND ANY EXPRESS OR IMPLIED WARRANTIES, INCLUDING, BUT NOT LIMITED TO, THE IMPLIED WARRANTIES OF MERCHANTABILITY AND FITNESS FOR A PARTICULAR PURPOSE ARE DISCLAIMED. IN NO EVENT SHALL THE COPYRIGHT OWNER OR CONTRIBUTORS BE LIABLE FOR ANY DIRECT, INDIRECT, INCIDENTAL, SPECIAL, EXEMPLARY, OR CONSEQUENTIAL DAMAGES (INCLUDING, BUT NOT LIMITED TO, PROCUREMENT OF SUBSTITUTE GOODS OR SERVICES; LOSS OF USE, DATA, OR PROFITS; OR BUSINESS INTERRUPTION) HOWEVER CAUSED AND ON ANY THEORY OF LIABILITY, WHETHER IN CONTRACT, STRICT LIABILITY, OR TORT (INCLUDING NEGLIGENCE OR OTHERWISE) ARISING IN ANY WAY OUT OF THE USE OF THIS SOFTWARE, EVEN IF ADVISED OF THE POSSIBILITY OF SUCH DAMAGE.

3.5 MCD-ST Liberty Software License Agreement v2

SLA0044 Rev5/February 2018

BY INSTALLING COPYING, DOWNLOADING, ACCESSING OR OTHERWISE USING THIS SOFTWARE OR ANY PART THEREOF (AND THE RELATED DOCUMENTATION) FROM STMICROELECTRONICS INTERNATIONAL N.V, SWISS BRANCH AND/OR ITS AFFILIATED COMPANIES (STMICROELECTRONICS), THE RECIPIENT, ON BEHALF OF HIMSELF OR HERSELF, OR ON BEHALF OF ANY ENTITY BY WHICH SUCH RECIPIENT IS EMPLOYED AND/OR ENGAGED AGREES TO BE BOUND BY THIS SOFTWARE LICENSE AGREEMENT.

Under STMicroelectronics' intellectual property rights, the redistribution, reproduction and use in source and binary forms of the software or any part thereof, with or without modification, are permitted provided that the following conditions are met:

1. Redistribution of source code (modified or not) must retain any copyright notice, this list of conditions and the disclaimer set forth below as items 10 and 11.
2. Redistributions in binary form, except as embedded into microcontroller or microprocessor device manufactured by or for STMicroelectronics or a software update for such device, must reproduce any copyright notice provided with the binary code, this list of conditions, and the disclaimer set forth below as items 10 and 11, in documentation and/or other materials provided with the distribution.
3. Neither the name of STMicroelectronics nor the names of other contributors to this software may be used to endorse or promote products derived from this software or part thereof without specific written permission.
4. This software or any part thereof, including modifications and/or derivative works of this software, must be used and execute solely and exclusively on or in combination with a microcontroller or microprocessor device manufactured by or for STMicroelectronics.
5. No use, reproduction or redistribution of this software partially or totally may be done in any manner that would subject this software to any Open Source Terms. "Open Source Terms" shall mean any open source license which requires as part of distribution of software that the source code of such software is distributed therewith or otherwise made available, or open source license that substantially complies with the Open Source definition specified at www.opensource.org and any other comparable open source license such as for example GNU General Public License (GPL), Eclipse Public License (EPL), Apache Software License, BSD license or MIT license.
6. STMicroelectronics has no obligation to provide any maintenance, support or updates for the software.
7. The software is and will remain the exclusive property of STMicroelectronics and its licensors. The recipient will not take any action that jeopardizes STMicroelectronics and its licensors' proprietary rights or acquire any rights in the software, except the limited rights specified hereunder.
8. The recipient shall comply with all applicable laws and regulations affecting the use of the software or any part thereof including any applicable export control law or regulation.
9. Redistribution and use of this software or any part thereof other than as permitted under this license is void and will automatically terminate your rights under this license.

10. THIS SOFTWARE IS PROVIDED BY STMICROELECTRONICS AND CONTRIBUTORS "AS IS" AND ANY EXPRESS, IMPLIED OR STATUTORY WARRANTIES, INCLUDING, BUT NOT LIMITED TO, THE IMPLIED WARRANTIES OF MERCHANTABILITY, FITNESS FOR A PARTICULAR PURPOSE AND NON-INFRINGEMENT OF THIRD PARTY INTELLECTUAL PROPERTY RIGHTS, WHICH ARE DISCLAIMED TO THE FULLEST EXTENT PERMITTED BY LAW. IN NO EVENT SHALL STMICROELECTRONICS OR CONTRIBUTORS BE LIABLE FOR ANY DIRECT, INDIRECT, INCIDENTAL, SPECIAL, EXEMPLARY, OR CONSEQUENTIAL DAMAGES (INCLUDING, BUT NOT LIMITED TO, PROCUREMENT OF SUBSTITUTE GOODS OR SERVICES; LOSS OF USE, DATA, OR PROFITS; OR BUSINESS INTERRUPTION) HOWEVER CAUSED AND ON ANY THEORY OF LIABILITY, WHETHER IN CONTRACT, STRICT LIABILITY, OR TORT (INCLUDING NEGLIGENCE OR OTHERWISE) ARISING IN ANY WAY OUT OF THE USE OF THIS SOFTWARE, EVEN IF ADVISED OF THE POSSIBILITY OF SUCH DAMAGE.
11. EXCEPT AS EXPRESSLY PERMITTED HEREUNDER, NO LICENSE OR OTHER RIGHTS, WHETHER EXPRESS OR IMPLIED, ARE GRANTED UNDER ANY PATENT OR OTHER INTELLECTUAL PROPERTY RIGHTS OF STMICROELECTRONICS OR ANY THIRD PARTY.

[de] Wichtige Hinweise zur Installation/Montage

Die Installation/Montage muss durch eine für die Arbeiten zugelassene Fachkraft unter Beachtung der geltenden Vorschriften erfolgen. Nichtbeachten der Vorgaben kann zu Sachschäden und/oder Personenschäden bis hin zur Lebensgefahr führen.

- ▶ Lieferumfang auf Unversehrtheit prüfen. Nur einwandfreie Teile einbauen.
- ▶ Mitgeltende Anleitungen von Anlagenkomponenten, Zubehör und Ersatzteilen beachten.
- ▶ Vor allen Arbeiten: Anlage allpolig spannungsfrei machen.

Vereinfachte EU-Konformitätserklärung betreffend Funkanlagen

Hiermit erklärt Bosch Thermotechnik GmbH, dass das in dieser Anleitung beschriebene Produkt MX200 mit Funktechnologie der Richtlinie 2014/53/EU entspricht.

Der vollständige Text der EU-Konformitätserklärung ist im Internet verfügbar: www.buderus.de.

Elektro- und Elektronik-Altgeräte



Nicht mehr gebrauchsfähige Elektro- oder Elektronikgeräte müssen getrennt gesammelt und einer umweltgerechten Verwertung zugeführt werden (Europäische Richtlinie über Elektro- und Elektronik-Altgeräte).

Nutzen Sie zur Entsorgung von Elektro- oder Elektronik-Altgeräten die länderspezifischen Rückgabe- und Sammelsysteme.

[en] Important notes on installation/assembly

The installation/assembly must be carried out by a contractor who is authorised to do the work, following these instructions and with due regard to the relevant regulations. Noncompliance with specifications can result in material damage and/or personal injury, the latter of which may even be fatal.

- ▶ Check that the contents of the delivery are undamaged. Only fit parts which are in a faultless condition.
- ▶ Observe all the relevant instructions for other system components, accessories and spare parts.
- ▶ Before starting any work: disconnect the system from the power supply across all phases.

Simplified EU Declaration of Conformity regarding radio equipment

Bosch Thermotechnik GmbH hereby declares, that the MX200 product described in these instructions complies with the Directive 2014/53/EU.

The complete text of the EU Declaration of Conformity is available on the Internet: www.buderus.co.uk.

Old electrical and electronic appliances



Electrical or electronic appliances that are no longer serviceable must be collected separately and sent for environmentally compatible recycling (in accordance with the European Directive on Waste Electrical and Electronic Equipment).

To dispose of old electrical or electronic appliances, you should use the return and collection systems put in place in the country concerned.

[fr] Instructions importantes pour l'installation/le montage

L'installation/le montage doit être effectué(e) par un spécialiste agréé pour les opérations concernées et dans le respect de la présente notice et des prescriptions applicables. Le non-respect des prescriptions peut entraîner des dommages matériels et/ou des dommages personnels, voire la mort.

- ▶ Vérifier si le contenu de la livraison est en bon état. N'utiliser que des pièces en parfait état.
- ▶ Respecter également les notices des composants de l'installation, des accessoires et des pièces de rechange.
- ▶ Avant tous les travaux : couper la tension sur tous les pôles de l'installation.

Déclaration de conformité simplifiée relative aux installations radio

Par la présente, Bosch Thermotechnik GmbH déclare que les produits MX200 avec technologie radio décrits dans cette notice sont conformes à la directive 2014/53/UE.

Le texte complet de la déclaration de conformité UE est disponible sur Internet : www.buderus.be.

Appareils électriques et électroniques usagés



Les appareils électriques et électroniques hors d'usage doivent être collectés séparément et soumis à une élimination écologique (directive européenne sur les appareils usagés électriques et électroniques).

Pour l'élimination des appareils électriques et électroniques usagés, utiliser les systèmes de renvoi et de collecte spécifiques au pays.

[es] Indicaciones importantes para instalación/montaje

La instalación/el montaje debe realizarla personal especializado que esté autorizado para realizar estos trabajos y que tenga en cuenta estas instrucciones y la normativa vigente. El incumplimiento de las normas puede provocar daños materiales y/o personales e incluso la muerte.

- ▶ Comprobar la integridad del volumen de suministro. Montar únicamente las piezas que estén correctas.
- ▶ Respetar las instrucciones de referencia de los componentes de la instalación, los accesorios y las piezas de repuesto.
- ▶ Antes de todos los trabajos: eliminar la tensión en todos los polos de la instalación.

Declaración de conformidad CE simplificada para instalaciones de radioemisión

Mediante la presente, Bosch Thermotechnik GmbH declara que el producto MX200, descrito en este manual, corresponde a la tecnología de radioemisión de la directiva 2014/53/CE.

El texto completo de la declaración de conformidad está disponible en internet: www.bosch-thermotechnology.com.

Aparatos usados eléctricos y electrónicos



Los aparatos eléctricos y electrónicos inservibles deben separarse para su eliminación y reutilizarlos de acuerdo con el medio ambiente (Directiva Europea de Residuos de aparatos eléctricos y electrónicos).

Utilice los sistemas de almacenamiento y colecta para la eliminación de residuos de aparatos eléctricos y electrónicos.

[cs] Důležité pokyny k instalaci/montáži

Instalaci/montáž musí při dodržení pokynů uvedených v tomto návodu a platných předpisů provést odborný pracovník s příslušným oprávněním pro tyto práce. Nedodržení požadavků může způsobit materiální škody a/nebo poškodit zdraví osob, popř. i ohrozit život.

- ▶ Zkontrolujte, zda rozsah dodávky nebyl porušen. Montujte jen nezávadné díly.
- ▶ Řiďte se souvisejícími návody pro komponenty zařízení, příslušenství a náhradní díly.
- ▶ Před započetím všech prací: vypněte kompletně napájení do zařízení.

Zjednodušené prohlášení o shodě EU týkající se rádiových zařízení

Tímto prohlašuje společnost Bosch Thermotechnik GmbH, že výrobek MX200 s rádiovou technologií popsáný v tomto návodu odpovídá směrnici 2014/53/EU.

Úplný text prohlášení o shodě EU je k dispozici na internetu: www.buderus.cz.

Stará elektrická a elektronická zařízení



Elektrická nebo elektronická zařízení, která již nejsou způsobilá k užívání, je nutno shromážďovat odděleně a odevzdat k ekologické recyklaci (Evropská směrnice o starých elektrických a elektronických zařízeních).

K likvidaci starých elektrických nebo elektronických zařízení využijte vratné a sběrné systémy vybudované v dané zemi.

[da] Vigtige anvisninger til installationen/monteringen

Installationen/monteringen skal foretages af en godkendt installatør under overholdelse af denne vejledning og de gældende forskrifter. Manglende overholdelse af bestemmelserne kan føre til materielle skader og/eller personskader, som kan være livsfarlige.

- ▶ Kontrollér, at leveringsomfanget er intakt og uden skader. Installér kun dele, som er intakte og uden skader.
- ▶ Overhold de gældende vejledninger til anlægskomponenter, tilbehør og reservedele.
- ▶ Før arbejdet udføres: Afbryd anlægget, så det er spændingsløst på alle poler.

Forenklet EU-overensstemmelseserklæring til radioanlæg

Hermed erklærer Bosch Thermotechnik GmbH, at produktet MX200 med radioteknologi, der er beskrevet i denne vejledning, opfylder direktiv 2014/53/EU.

EU-overensstemmelseserklæringens fulde tekst findes på internettet: www.buderus.dk.

Udtjente elektro- og elektronikprodukter



Elektro- og elektronikprodukter skal samles sammen adskilt og indleveres på genbrugsstationen i henhold til de europæiske direktiver for elektronikaffald.

Anvend de nationale genanvendelses- og indsamlingssystemer til bortskaftelse af elektro- og elektronikaffald.

[et] Olulised juhised paigaldamiseks/montaažiks

Paigaldamist/montaaži tohib läbi viia vaid selleks volitusi omav spetsialist, arvestades kehtivaid nõudeid. Nõuete mittejärgimisega võivad kaasneda eluohtlikud vigastused ja/või seadme kahjustused.

- ▶ Tuleb kontrollida, et kõik tarnekomplekti kuuluv on kahjustamata. Paigaldada võib ainult laitmatus korras olevaid detaile.
- ▶ Tuleb järgida kõiki seadme komponentide, tarvikute ja varuosade kohta kaaskehtivaid juhendeid.
- ▶ Enne kõigi tööde alustamist: muuta seadme kõik faasid pingevabaks.

Lihtsustatud EÜ vastavusdeklaratsioon raadioseadmete kohta

Käesolevaga deklareerib Bosch Thermotechnik GmbH, et selles juhendis kirjeldatav toode on kooskõlas MX200 direktiivi 2014/53/EL kohase raadiotehnoloogiaga.

EÜ vastavusdeklaratsiooni terviktekst on saadaval internetis: www.bosch-thermotechnology.com.

Vanad elektri- ja elektroonikaseadmed



Kasutuselt kõrvaldatud elektri- ja elektroonikaseadmeid tuleb eraldi kokku koguda ja loodushoidlikku jäätmekäitlusse suunata (läheldes Euroopa direktiividest vanade elektri- ja elektroonikaseadmete kohta).

Vanad elektri- ja elektroonikaseadmed tuleb kasutuselt kõrvaldada, kasutades konkreetse riigi tagastamis- ja kogumissüsteeme.

[fi] Tärkeitä asennus- ja kokoonpano-ohjeita

Näihin töihin hyväksytyn ammattiasentajan pitää suorittaa asennus- ja kokoonpanotyöt voimassa olevien määräysten mukaisesti. Ohjeiden noudattamatta jättäminen voi aiheuttaa aineellisia vahinkoja ja/tai jopa hengenvaarallisia henkilövahinkoja.

- ▶ Tarkasta, että toimitettu tuote on vahingoittumaton. Käytä asennuksessa ainoastaan moitteettomia osia.
- ▶ Noudata laitekomponenttien, lisätarvikkeiden ja varaosien asianomaisia ohjeita.
- ▶ Tee laitteisto kaikista navoistaan jännitteettömäksi ennen töiden aloittamista.

Radiolaitteita koskeva yksinkertaistettu EU-vaatimustenmukaisuusvakuutus

Täten Bosch Thermotechnik GmbH vakuuttaa, että tässä ohjeessa kuvattu tuote MX200 vastaa direktiivin 2014/53/EU mukaista radiolaiteteknologiaa.

EU-vaatimustenmukaisuusvakuutuksen täydellinen teksti löytyy Internetistä, ks.: www.bosch-thermotechnology.com.

Sähkö- ja elektroniikkalaiteromu



Ei enää käyttökelpoiset sähkö- ja elektroniikkalaitteet pitää kerätä erikseen ja toimittaa ympäristöystävälliseen kierrätykseen (Euroopassa vallitseva direktiivi sähkö- ja elektroniikkalaiteromusta).

Hyödynnä sähkö- ja elektroniikkalaiteromun hävittämisessä maakohtaisia palautus- ja keräysjärjestelmiä.

[hr] Važne upute za postavljanje/montažu

Instalacija/montaža mora biti učinjena od strane ovlaštenog stručnjaka za rad te u skladu s važećim propisima. Nepoštivanje uputa može dovesti do materijalnih šteta i/ili osobnih ozljeda ili opasnosti po život.

- ▶ Kontrolirajte opseg isporuke na neoštećenost. Instalirajte samo ispravne dijelove.
- ▶ Pridržavajte se važećih uputa komponenata postrojenja, pribora i zamjenskih dijelova.
- ▶ Prije svih radova: svepolno isključite iz napona.

Pojednostavljena EU-izjava o sukladnosti u vezi s radijskom opremom

Ovime Bosch Thermotechnik GmbH izjavljuje da je proizvod MX200 s radijskom tehnologijom koji je opisan u ovom uputstvu u skladu s Direktivom 2014/53/EU.

Cjeloviti tekst EU-izjave o sukladnosti dostupan je na internetu: www.buderus.com.hr.

Elektronički i električki stari uređaji



Elektroničke i električke stare uređaje koji se više ne koriste se moraju odvojeno sakupiti i primjereno zbrinuti (Europska Direktiva o otpadu električne i elektroničke opreme).

Za odlaganje električnih ili elektroničkih starih uređaja poštujujte smjernice za prikupljanje i vraćanje otpada za pojedinu zemlju.

[hu] Fontos tudnivalók az installáláshoz/szereléshez

A telepítést/szerelést egy, a munkálatokra felhatalmazott szakembernek kell végeznie, jelen utasítás és az érvényes előírások figyelembevételével. Az előírások figyelmen kívül hagyása anyagi károkhhoz és/vagy személyi sérülésekhez vagy akár életveszélyhez is vezethetnek.

- ▶ Ellenőrizze a szállítási terjedelem sértetlenségét. Csak kifogástalan elemeket és alkatrészeket építsen be.
- ▶ A rendszerkomponensek, tartozékok és pótalkatrészek együtt érvényes útmutatóit vegye figyelembe.
- ▶ Minden munkavégzés előtt: az elektromos berendezést minden pólusán kapcsolja feszültségmentes állapotra.

Egyszerűsített EU megfeleléségi nyilatkozat rádiótechnológiás berendezésekhez

Egyszerűsített EU megfeleléségi nyilatkozat rádiótechnológiás berendezésekhez
A Bosch Thermotechnik GmbH ezennel kijelenti, hogy az ebben az utasításban ismertetett rádiótechnológiás termék MX200 megfelel a 2014/53/EU irányelv követelményeinek.

Az EU megfeleléségi nyilatkozat teljes szövege az Interneten elérhető: www.buderus.com.hr.

Régi elektromos és elektronikus készülékek



A már nem használható elektromos vagy elektronikus készülékeket külön kell gyűjteni, és le kell adni környezetkímélő hasznosítás céljából (európai irányelv a régi elektromos és elektronikus készülékekről).

A régi elektromos vagy elektronikus készülékek ártalmatlanításához használja az országspecifikus visszavételi és gyűjtőrendszereket.

[it] Avvertenze importanti per l'installazione/il montaggio

L'installazione/il montaggio deve aver luogo ad opera di una ditta specializzata ed autorizzata in osservanza di queste istruzioni e delle direttive vigenti. L'inosservanza delle indicazioni può causare lesioni alle persone e/o danni materiali fino ad arrivare al pericolo di morte.

- ▶ Verificare che il volume di fornitura sia completo e non presenti nessun tipo di danno. Installare solo parti in stato perfetto.
- ▶ Osservare le istruzioni allegate dei componenti dell'impianto, degli accessori e delle parti di ricambio.
- ▶ Prima di tutti i lavori: staccare completamente l'alimentazione elettrica dell'impianto.

Dichiarazione di conformità UE semplificata relativa agli impianti radio

Con la presente documentazione la scrivente dichiara che il prodotto MX200 descritto in questo manuale è conforme alla tecnologia radio della direttiva 2014/53/UE.

Il testo completo della dichiarazione di conformità UE è disponibile su Internet. www.buderus.it.

Apparecchi elettronici ed elettrici dismessi



Gli apparecchi elettronici ed elettrici non più utilizzabili devono essere raccolti separatamente e portati presso un centro di smaltimento eco-compatibile (direttiva europea relativa agli apparecchi elettronici ed elettrici dismessi).

Per lo smaltimento di apparecchi elettronici ed elettrici dismessi utilizzare i sistemi di restituzione e raccolta specifici del paese.

[lt] Svarbios instaliavimo ir (arba) montavimo nuorodos

Instaliavimo / montavimo darbus, laikydamiesi šios instrukcijos reikalavimų ir galiojančių taisyklių, privalo atlikti šiems darbams įgalioti specialistai. Nesilaikant nurodymų, galima patirti materialinės žalos ir / arba gali būti sužaloti asmenys ar net iškilti pavojus gyvybei.

- ▶ Patikrinkite, ar pristatytame komplekte yra visos reikiamos dalys. Įmontuokite tik nepriekaištingos būklės dalis.
- ▶ Taip pat laikykitės įrenginio komponentų, priedų ir atsarginių dalių galiojančių instrukcijų.
- ▶ Prieš pradėdami bet kokius darbus: atjunkite įrenginio visų fazių srovę.

Supaprastinta ES atitikties deklaracija, susijusi radijo ryšio įranga

Bosch Thermotechnik GmbH patvirtina, kad šioje instrukcijoje aprašytas gaminys MX200 su radijo ryšio įranga atitinka 2014/53/ES direktyvos reikalavimus.

Visas ES atitikties deklaracijos tekstas pateiktas internete: www.bosch-thermotechnology.com.

Naudoti elektriniai ir elektroniniai prietaisai



Naudoti elektriniai ir elektroniniai prietaisai turi būti atskirai surenkami ir perdribami aplinkai nekenksmingu būdu (Europos Direktyva dėl naudotų elektrinių ir elektroninių prietaisų utilizavimo).

Naudotų elektrinių ir elektroninių prietaisų utilizavimui naudokitės šalyje veikiančiomis esančiomis grąžinimo ir surinkimo sistemomis.

[lv] Svarīgi norādījumi par iekārtas uzstādīšanu / montāžu

Uzstādīšanu/montāžu jāveic atbilstošajiem darbiem sertificētam speciālistam, ievērojot šo instrukciju un spēkā esošos noteikumus. Neievērojot šos noteikumus, iespējami mantiskie zaudējumi un/vai traumas vai pat apdraudējums dzīvībai.

- ▶ Pārbaudiet, vai piegādes komplekts nav bojāts. Montāžai lietojiet tikai nevainojamā stāvoklī esošus komponentus.
- ▶ Ievērojiet iekārtas komponentu, piederumu un rezerves daļu instrukcijas.
- ▶ Pirms jebkādu darbu uzsākšanas: izslēdziet iekārtas strāvas padevi visiem poliem.

Vienkāršota ES atbilstības deklarācija radioiekārtām

Ar šo Bosch Thermotechnik GmbH apliecina, ka šajā instrukcijā aprakstītais izstrādājums MX200 ar radiotehniku atbilst Direktīvas 2014/53/ES prasībām.

ES atbilstības deklarācijas pilns teksts pieejams internetā: www.bosch-thermotechnology.com.

Nolietotās elektriskās un elektroniskās ierīces



Atsevišķi savāciet vairs neizmantojamās elektriskās un elektroniskās ierīces un nododiet tās videi draudzīgai pārstrādei (Eiropas Savienības direktīva par nolietotām elektriskām un elektroniskām ierīcēm).

Nolietotu elektrisko un elektronisko ierīču utilizācijai izmantojiet attiecīgajā valstī pieejamās atgriešanas un savākšanas sistēmas.

[nl] Belangrijke aanwijzingen betreffende de installatie/montage

De installatie/montage moet worden uitgevoerd door een voor de werkzaamheden geautoriseerde installateur, rekening houdend met deze instructie en de geldende voorschriften. Het niet aanhouden van deze instructies kan materiële schade, persoonlijk letsel of zelfs levensgevaar tot gevolg hebben.

- ▶ Controleer of de leveringsomvang niet beschadigd is. Monteer alleen onderdelen die in optimale conditie verkeren.
- ▶ Respecteer tevens geldende handleidingen van installatiecomponenten, toebehoren en reserveonderdelen.
- ▶ Voor alle werkzaamheden: installatie over alle polen spanningsloos schakelen.

Vereenvoudigde conformiteitsverklaring betreffende radiografische installaties

Hierbij verklaart Bosch Thermotechnik GmbH, dat het in deze instructie genoemde product MX200 met radiografische technologie aan de richtlijn 2014/53/EU voldoet.

De volledige tekst van de EU-conformiteitsverklaring is via internet beschikbaar: www.buderus.nl.

Afgedankte elektrische en elektronische apparaten



Niet meer te gebruiken elektrische en elektronische apparaten moeten gescheiden worden ingezameld en aan een milieuvriendelijke afvalverwerking worden toegevoerd (Europese richtlijn betreffende elektrische en elektronische afgedankte apparaten).

Gebruik voor het afvoeren van elektrische en elektronische afgedankte apparaten de nationale retour- en inleversystemen.

[no] Viktig informasjon om installasjon/montering

Installasjonen/monteringen skal gjennomføres av autoriserte installatører, og installasjonsanvisningen samt gjeldende forskrifter skal følges. Feilbetjening kan føre til materielle skader og/eller personskafer med fare for tap av liv:

- ▶ Kontroller at leveransen er intakt. Bare intakte komponenter skal monteres.
- ▶ Vær oppmerksom på bruksanvisninger for anleggskomponenter, tilbehør og reservedeler.
- ▶ Før alle arbeider: Koble anlegget helt fra strømforsyningen.

Forenklet EU-konformitetserklæring for radioanlegg

Herved erklærer Bosch Thermotechnik GmbH at produktet som er beskrevet i denne anvisningen, MX200 med radioteknologi, samsvarer med direktiv 2014/53/EU.

Den fullstendige teksten for EU-konformitetserklæringen er tilgjengelig på internett: www.bosch-thermotechnology.com.

Elektrisk og elektronisk avfall



Elektriske eller elektroniske apparater som ikke lenger fungerer, skal oppbevares adskilt fra husholdningsavfall og leveres til godkjent gjenvinningsstasjon (Europeisk direktiv om elektrisk og elektronisk avfall).

Elektrisk og elektronisk avfall skal leveres til landsspesifikke retur- og gjenvinningsystemer for kassering.

[pl] Ważne wskazówki dotyczące instalacji/montażu

Instalację/montaż powinien wykonać specjalista uprawniony do tego typu prac z uwzględnieniem informacji podanych w niniejszej instrukcji oraz aktualnie obowiązujących przepisów. Ignorowanie tych wytycznych grozi szkodami materialnymi i/lub urazami cielesnymi ze śmiercią włącznie.

- ▶ Sprawdzić, czy zawartość dostawy nie jest naruszona. Montować tylko elementy będące w nienagannym stanie.
- ▶ Przestrzegać dodatkowych instrukcji dołączonych do komponentów instalacji, osprzętu i oraz części zamiennych.
- ▶ Przed przystąpieniem do wykonywania wszelkich prac: odłączyć instalację od zasilania sieciowego (wszystkie bieguny).

Skrócona deklaracja zgodności UE dot. urządzeń radiowych

Bosch Thermotechnik GmbH oświadcza niniejszym, że wyrób MX200 technologii radiowej opisany w tej instrukcji jest zgodny z dyrektywą 2014/53/UE.

Pełny tekst deklaracji zgodności UE dostępny jest w internecie: www.buderus.pl.

Zużyty sprzęt elektryczny i elektroniczny



Zużyty sprzęt elektryczny i elektroniczny musi być gromadzony oddzielnie i poddawany recyklingowi w sposób zgodny z przepisami o ochronie środowiska (europejska dyrektywa w sprawie zużytego sprzętu elektrycznego i elektronicznego).

W celu utylizacji zużytego sprzętu elektrycznego i elektronicznego należy skorzystać z systemu zbiórki tego typu odpadów obowiązującego w danym kraju.

[pt] Indicações importantes relativas à instalação/montagem

A instalação/montagem deve ser efectuada por um técnico autorizado para os trabalhos, respeitando este manual e as prescrições válidas. A inobservância das indicações pode provocar danos materiais e/ou pessoais e até mesmo perigo de morte.

- ▶ Verificar se o material fornecido está intacto. Montar apenas peças em perfeitas condições.
- ▶ Ter em consideração as instruções aplicáveis de componentes da instalação, acessórios e peças de substituição.
- ▶ Antes de todos os trabalhos: desligar a instalação da corrente em todos os pólos.

Declaração de conformidade UE simplificada relativamente a equipamentos de rádio

A Bosch Thermotechnik GmbH declara que o produto descrito neste manual MX200 corresponde à tecnologia de rádio da diretiva 2014/53/UE.

O texto completo da declaração de conformidade UE encontra-se disponível na internet: www.buderus.pt.

Aparelhos elétricos e eletrônicos em fim de vida



Os aparelhos elétricos e eletrônicos inutilizáveis devem ser recolhidos em separado e transferidos para uma reciclagem ecológica (Diretiva relativa aos resíduos de equipamentos elétricos e eletrônicos).

Para a eliminação de aparelhos elétricos e eletrônicos usados deve usar os sistemas de retorno e recolha adequados.

[ro] Indicații importante privind instalarea/montajul

Instalarea/montajul trebuie realizate de către un specialist autorizat pentru lucrările respective, respectându-se prezentele instrucțiuni și prescripțiile valabile. Nerespectarea indicațiilor poate conduce la daune materiale și/sau daune personale și pericol de moarte.

- ▶ Verificați dacă produsul livrat este intact. Montați numai piese fără defecte.
- ▶ Respectați instrucțiunile conexe referitoare la componentele instalației, accesorii și piese de schimb.
- ▶ Anterior tuturor lucrărilor: decupați instalația de la alimentarea cu tensiune la toți polii.

Declarație UE de conformitate simplificată privind echipamentele radio

Prin prezenta, Bosch Thermotechnik GmbH declară faptul că produsul MX200 prezentat în prezentele instrucțiuni corespunde tehnologiei echipamentelor radio prezentate în directiva 2014/53/UE.

Textul complet al declarației UE de conformitate este disponibil pe Internet: www.buderus.ro.

Deșeurile de echipamente electrice și electronice



Echipamentele electrice sau electronice scoase din uz trebuie colectate separat și depuse la un centru de colectare ecologic (Directiva europeană privind deșeurile de echipamente electrice și electronice).

Pentru eliminarea deșeurilor de echipamente electrice sau electronice utilizați sistemele de returnare și de colectare specifice țării.

[ru] Важные указания по подключению/монтажу

Подключение/монтаж должны выполнять только специалисты, имеющие допуск к выполнению таких работ, при соблюдении требований этой инструкции и действующих норм и правил. Несоблюдение требований может привести к повреждению оборудования и/или травмам людей вплоть до угрозы их жизни.

- ▶ Проверьте комплект поставки на наличие повреждений. Устанавливайте только детали без дефектов.
- ▶ Выполняйте требования сопутствующих инструкций на компоненты установки, дополнительное оборудование и запчасти.
- ▶ Перед выполнением любых работ: обесточьте установку отключением всех фаз.

Упрощенная Декларация соответствия нормам ЕС в отношении радиооборудования

Настоящим компания Bosch Thermotechnik GmbH заявляет, что описанное в данном руководстве радиооборудование типа MX200 отвечает Директиве 2014/53/ЕС.

Полный текст Декларации соответствия нормам ЕС приведен на сайте: www.buderus.ru.

Отслужившее свой срок электрическое и электронное оборудование



Непригодное к применению электрическое и электронное оборудование нужно собирать отдельно и отправлять на экологичную переработку (Европейская директива об отслужившем свой срок электрическом и электронном оборудовании).

Пользуйтесь для утилизации национальными системами приема и сбора отслужившего свой срок электрического и электронного оборудования.

[sk] Dôležité pokyny týkajúce sa inštalácie/montáže

Inštaláciu/montáž musí vykonať odborný personál, ktorý má oprávnenie pre výkon týchto prác, pričom musí dodržiavať pokyny uvedené v tomto návode a platné predpisy. Nedodržanie pokynov môže viesť k vzniku vecných škôd a/alebo poranení osôb, až s následkom smrti.

- ▶ Skontrolujte, či je dodávka neporušená. Montujte iba bezchybné komponenty.
- ▶ Dodržujte inštrukcie uvedené v súvisiacich návodoch ku komponentom zariadenia, príslušenstvu a náhradným dielom.
- ▶ Pred začiatkom všetkých prác: Odpojte všetky póly el. napájania zariadenia.

Zjednodušené vyhlásenie EÚ o zhode týkajúce sa rádiových zariadení

Týmto spoločnosť Bosch Thermotechnik GmbH vyhlasuje, že produkt MX200 s rádiovou technikou popísaný v tomto návode zodpovedá smernici 2014/53/EÚ.

Úplný text vyhlásenia EÚ o zhode je k dispozícii na internete: www.buderus.sk.

Elektrické a elektronické zariadenia



Nefunkčné elektrické alebo elektronické zariadenia je nutné pri zbere separovať a dopraviť ich na ekologickú recykláciu (Smernica EÚ o použitých elektrických a elektronických zariadeniach).

Pri likvidácii použitých elektrických a elektronických zariadení využívajte systémy na ich odovzdávanie a zberné systémy v príslušnej krajine.

[sl] Pomembni napotki za namestitev/montažo

Inštalacijo/montažo lahko izvede samo pooblaščen strokovnjak ob upoštevanju teh navodil in veljavnih predpisov. Pri neupoštevanju navodil lahko pride do stvarne škode in/ali poškodb oseb, kar lahko vključuje tudi življenjsko nevarnost.

- ▶ Preverite, ali dobava ni poškodovana. Vgradite samo nepoškodovane dele.
- ▶ Upoštevajte priložena veljavna navodila komponent naprave, priborov in nadomestnih delov.
- ▶ Pred vsemi deli: izklopite napravo iz vseh polov.

Poenostavljena ES-Izjava o skladnosti v zvezi z radijskimi napravami

S to izjavo Bosch Thermotechnik GmbH potrjuje, da proizvod MX200 z radijsko tehnologijo, opisan v teh navodilih, ustreza zahtevam Direktive 2014/53/EU.

Popolno besedilo ES-Izjave o skladnosti je na voljo na spletnem naslovu: www.bosch-thermotechnology.com.

Odpadna električna in elektronska oprema



Električne in elektronske naprave, ki niso več uporabne, je treba zbirati ločeno in jih okolju varno reciklirati (evropska direktiva o odpadni električni in elektronski opremi).

Za odstranjevanje odpadne električne in elektronske opreme uporabite lokalna zbirna mesta in sisteme za ekološko odstranjevanje.

[sr] Važna uputstva za ugradnju i montažu

Ovu instalaciju/montažu moraju da obave stručna lica koja su ovlašćena za obavljanje takvih radova u skladu sa ovim uputstvom i važećim propisima. Nepoštovanje ovih napomena može da dovede do materijalnih šteta i/ili telesnih povreda, pa čak i do opasnosti po život.

- ▶ Proveriti da li postoje oštećenja u okviru sadržaja isporuke. Ugrađivati samo potpuno ispravne delove.
- ▶ Pridržavati se priloženih uputstava za komponente sistema, dodatnu opremu i rezervne delove.
- ▶ Pre svih radova: sistem potpuno isključiti iz struje.

Pojednostavljena EU Izjava o usaglašenosti za bežične uređaje

Ovim Bosch Thermotechnik GmbH izjavljuje da u ovom uputstvu opisan proizvod, MX200 sa bežičnom tehnologijom, odgovara smernici 2014/53/EU.

Kompletan tekst EU Izjave o usaglašenosti na raspolaganju je na internetu: www.buderus.co.rs.

Dotrajali električni i elektronski uređaji



Električni ili elektronski uređaji koji više nisu upotrebljivi moraju odvojeno da se skupljaju i proslede na dalju ekološku obradu (Evropska direktiva o dotrajalim električnim i elektronskim uređajima).

Za odlaganje na otpad dotrajalih električnih i elektronskih uređaja koristiti komunalne sisteme specifične za zemlju primene.

[sv] Viktiga anvisningar för installation/montering

Installationen/monteringen måste utföras av en behörig och tekniskt utbildad person enligt denna anvisning samt gällande föreskrifter.

Om specifikationer inte följs kan det leda till skador på utrustning och/eller personskador och till och med livsfara.

- ▶ Kontrollera att leveransen är intakt. Installera endast felfria delar.
- ▶ Tillämpliga instruktioner för systemkomponenter, tillbehör och reservdelar ska också följas.
- ▶ Före alla arbeten ska anläggningen försättas i spänningsfritt tillstånd.

Förenklad EU-konformitetsförklaring gällande radioutrustning

Härmed intygar Bosch Thermotechnik GmbH att produkten MX200 med radioutrustning som beskrivs i denna handbok överensstämmer med direktiv 2014/53/EU.

EU-konformitetsförklaringen i sin helhet finns tillgänglig på nätet: www.bosch-thermotechnology.com.

Avfall som utgörs av eller innehåller elektrisk och elektronisk utrustning



Förbrukad elektrisk eller elektronisk utrustning måste samlas in separat för miljövänlig återvinning i enlighet med EU-direktivet om avfall som utgörs av eller innehåller elektrisk och elektronisk utrustning.

Använd nationella återvinnings- och insamlingsystem för avfallshantering av elektriska eller elektroniska uttjänta föremål.

[tr] Kurulum/Montaj ile ilgili önemli uyarılar

Kurulum/montaj, bu çalışmalarını yapmasına müsaade edilen uzman kişiler tarafından işbu kılavuz ve geçerli yönetmelikler dikkate alınarak yapılmalıdır. Öngörülen bilgilerin dikkate alınmaması, maddi hasarlara ve/veya yaralanmalara ve ölüm tehlikesine yol açabilir.

- ▶ Teslimat kapsamının eksiksiz ve sorunsuz olduğunu kontrol edin. Sadece kusursuz durumdaki parçaları monte edin.
- ▶ Tesisat parçalarına, aksesuarlara ve yedek parçalara ait talimatları dikkate alın.
- ▶ Çalışmaya başlamadan önce: Enerji beslemesinin tüm kutuplarını ayırarak tesisatın enerji beslemesini kesin.

Telsiz ekipmanları ile ilgili basitleştirilmiş AT Uygunluk Beyanı

Bosch Thermotechnik GmbH firması, bu kılavuzda anlatılan telsiz teknolojisine sahip MX200 ürününün 2014/53/AT sayılı yönetmeliğe uygun olduğunu beyan ediyor.

AT Uygunluk Beyanı'nın eksiksiz metnine İnternet üzerinden ulaşabilirsiniz: www.buderus-tr.com.

Eski Elektrikli ve Elektronik Cihazlar



Kullanılamaz durumdaki elektronik veya elektrikli cihazlar, ayrı bir yerde toplanmalı ve çevre korumasına uygun geri dönüşüm uygulaması için ilgili kuruluşlara teslim edilmelidir (eski elektronik ve elektrikli cihazlara ilişkin Avrupa Birliği yönetmeliği).

Eski elektrikli veya elektronik cihazları imha etmek için, ülkeye özgü iade ve toplama sistemlerini kullanın.

[fl] Belangrijke aanwijzingen betreffende de installatie/montage

De installatie/montage moet worden uitgevoerd door een voor de werkzaamheden geautoriseerde installateur rekening houdend met deze handleiding en de geldende voorschriften. Niet aanhouden van de instructies kan materiële schade, persoonlijk letsel of zelfs levensgevaar tot gevolg hebben.

- ▶ Controleer of de leveringsomvang niet beschadigd is. Monteer alleen onderdelen die in optimale toestand verkeren.
- ▶ Respecteer tevens geldende handleidingen van installatiecomponenten, toebehoren en reserveonderdelen.
- ▶ Voor alle werkzaamheden: alle spanningsvoerende delen spanningsloos maken (alle fasen!).

Vereenvoudigde conformiteitsverklaring betreffende radiografische installaties

Hierbij verklaart Bosch Thermotechnik GmbH, dat het in deze instructie genoemde product MX200 met radiografische technologie aan de richtlijn 2014/53/EU voldoet.

De volledige tekst van de EU-conformiteitsverklaring is via internet beschikbaar: www.buderus.be.

Afgedankte elektrische en elektronische apparatuur



Niet meer te gebruiken elektrische en elektronische apparaten moeten gescheiden worden ingezameld en aan een milieuvriendelijke afvalverwerking worden toegevoerd (Europese richtlijn betreffende elektrische en elektronische afgedankte apparaten).

Gebruik voor het afvoeren van elektrische en elektronische afgedankte apparaten de nationale retour- en inleversystemen.

[el] Σημαντικές υποδείξεις για την εγκατάσταση/συναρμολόγηση

Η εγκατάσταση/τοποθέτηση πρέπει να ανατίθεται σε εκπαιδευμένο για τις συγκεκριμένες εργασίες τεχνικό προσωπικό με τήρηση αυτών των οδηγιών καθώς και των σχετικών προδιαγραφών. Η μη τήρηση των οδηγιών είναι πιθανό να οδηγήσει σε υλικές ζημιές και/ή σωματικές βλάβες,

ή ακόμα και να θέσει σε κίνδυνο τη ζωή ατόμων.

- ▶ Ελέγξτε το περιεχόμενο παραγγελίας για τυχόν φθορές. Στην εγκατάσταση πρέπει να εγκαθίστανται μόνο εξαρτήματα που λειτουργούν άψογα.
- ▶ Λάβετε υπόψη τις συνοδευτικές οδηγίες που αφορούν τα εξαρτήματα της εγκατάστασης, τους πρόσθετους εξοπλισμούς και τα ανταλλακτικά.
- ▶ Πριν από οποιαδήποτε εργασία: Αποσυνδέστε όλους τους πόλους της εγκατάστασης από το ρεύμα.

Απλοποιημένη δήλωση συμμόρφωσης ΕΕ για ασύρματες εγκαταστάσεις

Με το παρόν δηλώνει ηBosch Thermotechnik GmbH, ότι το προϊόν MX200 που περιγράφεται στις παρούσες οδηγίες ανταποκρίνεται στην ασύρματη τεχνολογία της οδηγίας 2014/53/ΕΕ.

Το πλήρες κείμενο της δήλωσης συμμόρφωσης ΕΕ διατίθεται στο διαδίκτυο: www.buderus.gr.

Παλιές ηλεκτρικές και ηλεκτρονικές συσκευές



Οι ακατάλληλες πλέον για χρήση ηλεκτρικές και ηλεκτρονικές συσκευές πρέπει να συλλέγονται ξεχωριστά και να προωθούνται σε ανακύκλωση με φιλικές για το περιβάλλον διαδικασίες (Ευρωπαϊκή Οδηγία για παλιές ηλεκτρικές και ηλεκτρονικές συσκευές).

Για την απόρριψη των παλαιών ηλεκτρικών και ηλεκτρονικών συσκευών αξιοποιήστε τα συστήματα επιστροφής και συλλογής που ισχύουν στη χώρα σας.

[bg] Важни указания във връзка с инсталацията/монтажа

Инсталацията/монтажът трябва да се извършва от лицензиран за работите специалист в съответствие с настоящото ръководство и с приложимите разпоредби. Неспазването на предписанията може да доведе до материални щети и/или телесни повреди или дори опасност за живота.

- ▶ Проверете обема на доставката за невредимост. Монтирайте само части без дефекти.
- ▶ Съблюдавайте съответните ръководства на компоненти на уредбата, принадлежности и резервни части.
- ▶ Преди всички работи: На всички полюси уредбата не трябва да бъде под напрежение.

Опростена декларация за съответствие на ЕС за радиооборудване

С настоящото Bosch Thermotechnik GmbH декларира, че описаният в това ръководство продукт MX200 с радиоустройство съответства на Директива 2014/53/ЕС.

Пълният текст на декларацията за съответствие на ЕС е наличен в интернет: www.bosch-climate.bg.

Излезли от употреба електрически и електронни уреди



Излезлите от употреба електрически или електронни уреди трябва да се събират отделно и да се предадат за екологосъобразно рециклиране (Европейска директива за излезлите от употреба електрически и електронни уреди).

За изхвърляне на излезли от употреба електрически или електронни уреди използвайте прилаганата в съответната държава система за предаване и събиране.

[uk] Важливі вказівки щодо установки/монтажу

Встановлення/монтаж повинні виконувати фахівці, що допущені до виконання таких робіт, із дотриманням цієї інструкції та діючих приписів. Недотримання цих інструкцій може призвести до матеріальних збитків та/або травмування осіб, а також може бути небезпечним для життя.

- ▶ Перевірити комплект поставки на цілісність. Встановлювати лише деталі, що не мають дефектів.
- ▶ Дотримуватися чинних інструкцій для компонентів установки, додаткового приладдя та запасних частин.
- ▶ Перед здійсненням будь-яких робіт: знеструмити установку на всіх полюсах.

Спрощений сертифікат відповідності ЄС щодо радіотехніки

Таким чином, Bosch Thermotechnik GmbH заявляє, що MX200 з бездротовою технологією, описаний у цьому посібнику, відповідає Директиві 2014/53/ЄС.

Повний текст документу про відповідність продукції вимогам ЄС доступний на веб-сайті: www.buderus.ua.

Електричні та електронні старі прилади



Старі електричні й електронні прилади, які більше не використовуються, слід збирати окремо і відправляти на екологічно безпечну утилізацію (Директива ЄС про утилізацію електричних та електронних старих приладів).

Для утилізації відходів електричних та електронних старих приладів використовуйте системи збору та повернення в конкретних країнах.

Buderus

Bosch Thermotechnik GmbH
Sophienstrasse 30-32
D-35576 Wetzlar

www.bosch-thermotechnology.com